

# ELECTRIC MULTI DIRECTIONAL SIDELOADERS

**VERSATILE AND  
ENVIRONMENTALLY  
FRIENDLY  
IN SERIES**

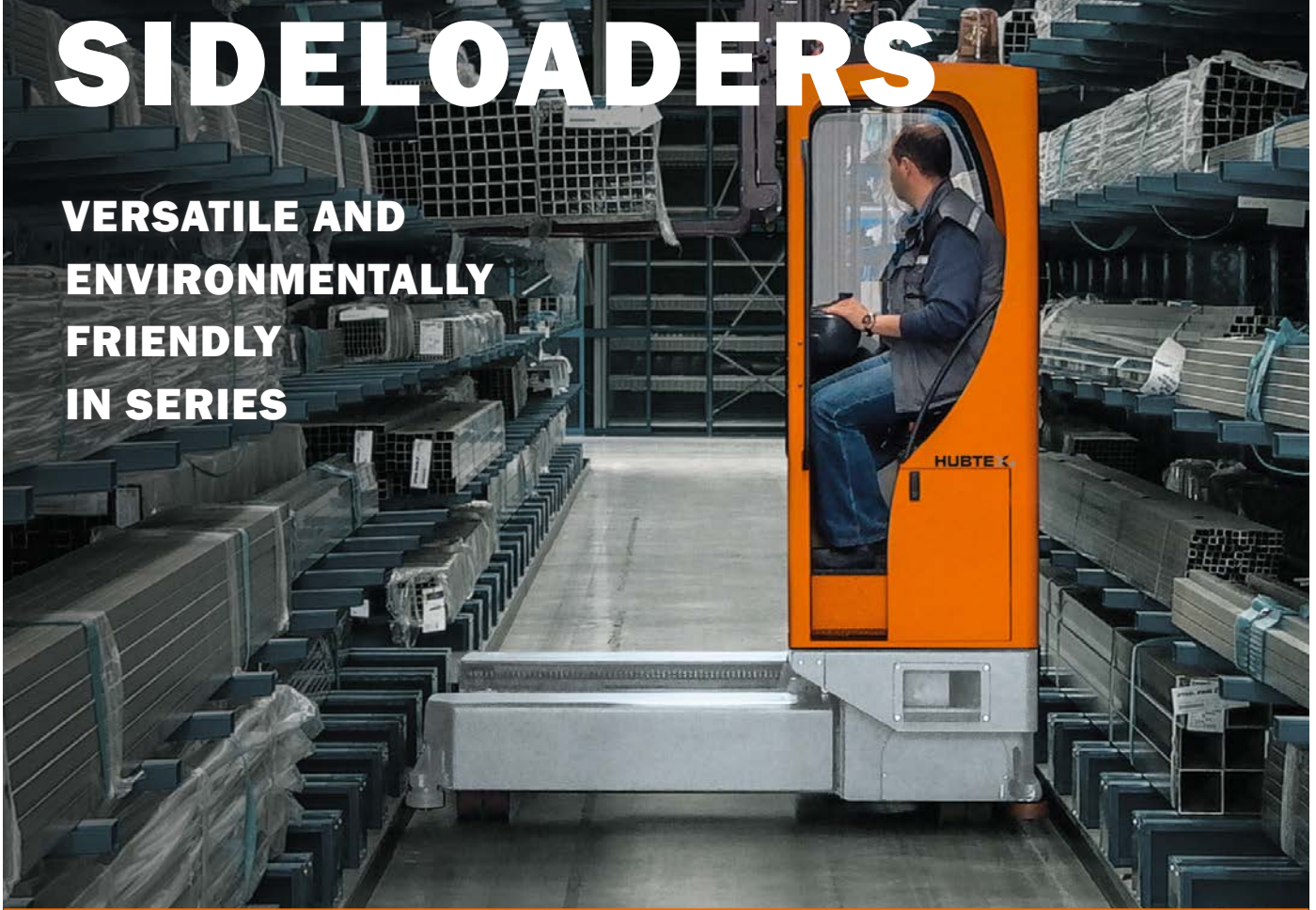

LOAD CAPACITIES FROM UP TO 20.0 TONNES  
LIFT HEIGHTS UP TO 12500 MM

[www.hubtex.com](http://www.hubtex.com)

**HUBTEX.**

WE CREATE THE UNIQUE

# VERSATILE AND ENVIRONMENTALLY FRIENDLY

HUBTEX offers multidirectional sideloaders with electric drive in the load capacity classes from 1.5 to 20.0 tonnes.

These all-purpose industrial trucks can be used for the handling of long goods, stacks of metal sheets, chip boards, tools, cable drums, rollers, oversized pallets and round bars in narrow aisle rack systems or in a freely moveable manner in the indoor and outdoor area.

Within the production series, the industrial trucks can be tailor-made to meet the individual requirements of the end user.

# Electric multi-directional sideloader in detail



➤ *Load capacities from 1.5 to 20.0 tonnes*

➤ *Indoor and outdoor application*

➤ *Electric powered  
quiet and environmentally friendly*

➤ *Fork carriage tilt  
for high derated capacities and  
safe handling at high lift heights*

➤ *Reduced energy and maintenance costs  
durch moderne Drehstromtechnik  
und Wegfall von Kohlebürsten*

➤ *Articulated frame  
for mechanical level compensation*

➤ *Reduced load arm height  
for optimal utilization of the lower storage rack level*

➤ *Guided operation  
in narrow aisles or free range operation*

➤ *Multidirectional steering  
for optimal manoeuvrability*

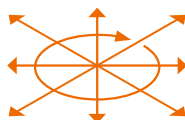

## THE SERIES AT A GLANCE:

- 2120 series
- 2121 series
- 2125 series
- 2130 series
- 2131 series
- 2140 series
- 2150 series
- 2132 series
- 2134 series
- Man Up series





*The vehicle can be equipped with various track guidance systems to ensure optimum use of the storage area.*

---



---

# Increased storage capacities – optimal efficiency

---



**UP TO 100% MORE STORAGE SPACE**

**FAST, SAFE AND EFFICIENT**

**LESS DAMAGE TO MERCHANDISE / LESS BREAKAGE**

Due to the use of HUBTEX siders, narrow aisles can be passed through without any problems and the distance between the rack rows reduced to a minimum. In this way, space is created for additional rack rows and new warehouse capacity. HUBTEX thus provides for a increased storage capacity and offers in the result an optimal utilization of storage space.

## SMALLER SHELF AISLE WIDTHS DUE TO MULTIDIRECTIONAL SIDELOADERS

Long or heavy loads with load capacities from 1.5 to 20.0 tons for bulky loads

- *Electric drive*
- *Indoor and outdoor application*
- *Handling / Transport / Order picking*
- *Guided in narrow aisle or freely manoeuvrable*

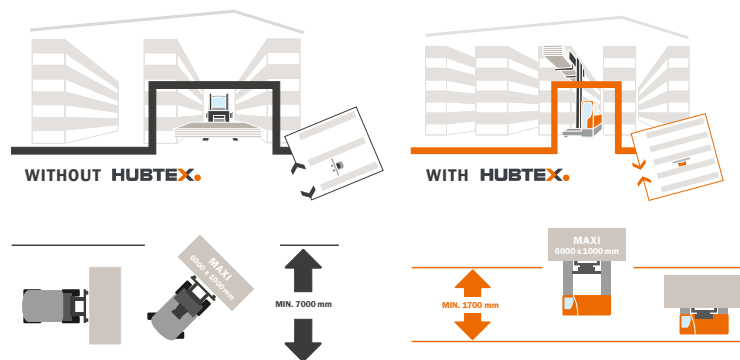

# Equipped for every application

## 2120

The 2120 series is a very compact and agile universal sideloader with multidirectional steering for the handling of pallets and long loads. Due to the short frame length, this series is also suitable for the use as fork-lift reach truck in the pallet rack system or as frontloader for block storage.

## 2121

The 2121 series is a universal sideloader with multidirectional steering for the handling of pallets and long loads. It is characterized by its compact design and is especially suitable for narrow aisle storage applications. The smallest possible aisle width can be achieved because of the choice of different cabins.



Series	2120	2121
Load capacity (t)	1.5 to 3.0	1.5 to 3.0
Load bed width (mm)	600 to 1600	600 to 1800
Lift height (mm)	up to 8500	up to 8500
Frame length (mm)	2090	2760
Load bed opening (mm)	1000	1340
Tyre equipment	PU / EL	PU / EL
Battery voltage (V)	48 V	48 V
Cabin	Q	Q / D / L / SU

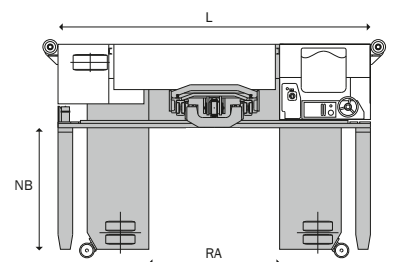

Q = Crosswise  
 D = Diagonal  
 L = Lengthwise  
 SU = Stand up

PU = Polyurethane  
 EL = Elastic



## 2125

The 2125 series is the most compact and agile universal sideloader with multidirectional steering in its class. The truck is suitable for the handling of pallets and long loads, in narrow aisle warehouses, indoor and outdoor application as well as on semi-solid substrates. With vertical AC motors it can be used outside in all weathers as well as inside in guided aisle operations.



## 2130 / 31

The series 2130 and 2131 are universal siders with multi-directional steering for handling of pallets and long loads. They can be optionally equipped with a short chassis length for block stacking or with a narrow cab / back frame for their use in rack system aisles. Different cabin versions are offered for individual requirements, from those for the smallest possible aisle width up to those for the highest possible operator comfort.

The siders are available with polyurethane (PU) tyres for pure indoor use or with elastic (EL) tyres for combined indoor and outdoor applications. Both series are equipped with travel motors which are constructed in an upright and water-protected manner, and can be used without hesitation in outdoor areas, even in poor weather conditions.

2125	2130 / 31
3.0 to 4.5	3.0 to 4.5 / 5.0 to 7.0
800 to 1800	600 to 2100
up to 10000	up to 10000
2440	2880 / 3170 / 3500
1340	1340 / 1630 / 1960
PU / EL	PU / EL (2030 series up to 5,0 t)
48 V	80 V
Q	Q / D / SU





## 2140

The 2140 series is a heavy duty multidirectional sideloader which is specifically designed for the narrowest of aisle and the handling of long loads. The truck lifts loads of max. 5,500 kg up to 10,000 mm.



## 2150

The Series 2150 multidirectional steering trucks are characterised by their robust design and extremely high load capacities. It transports and handles long and heavy loads in combined indoor and outdoor applications. It reaches speeds of up to 16 km/h due to its strong travel motors and large-sized elastic tyres (EL). The sideloader can be used without hesitation in outdoor areas, even in poor weather conditions. Spacious and ergonomically designed drivers' cabins in "XL size" offer highest comfort for the operator.

Series	2140	2150
Load capacity (t)	3.0 to 5.5	6.0 to 8.0
Load bed width (mm)	600 to 2100	800 to 2100
Lift height (mm)	up to 10000	up to 10000
Frame length (mm)	3350 / 3680	3720 / 4050 (DXL-Cabin: L + 270 mm)
Load bed opening (mm)	1340 / 1670	1630 / 1960
Tyre equipment	PU	EL
Battery voltage (V)	80 V	80 V
Cabin	L / SU	Q / QXL / DXL

Q = Crosswise

D = Diagonal

L = Lengthwise

SU = Stand up

PU = Polyurethane

EL = Elastic





## 2134

The sideloader with multidirectional steering is characterized by its robust design and high load capacities. The series is designed for the handling of heavy, extremely long and/or deep loads. With its large-sized polyurethane (PU) tyres, the sideloader is mainly used in the hall or in canopied outdoor areas. Spacious and ergonomically designed drivers' cabins in "XL size" offer optimal comfort for the operator.

## 2132

The 2132 vehicle series with multidirectional steering is the entry level for heavy load handling. With its soft elastic tyres, it handles long and heavy loads of up to 6000 kg in combined indoor and outdoor applications. The sideloader can be used without hesitation in outdoor areas, even in poor weather conditions. With its large-sized polyurethane (PU) tyres, the series has a load capacity of up to 10000 kg and is mainly used in the hall or in canopied outdoor areas.



2132	2134
6.0 to 10.0	12.0 to 20.0
800 to 2100	1000 to 2100
up to 10000	up to 10000
3490 / 3820	4000
1340 + 1630 / 1960	1960
PU (up to 10.0 t) / EL (up to 6.0 t)	PU / EL (up to 12.0 t)
80 V	80 V
Q	Q / QXL / DXL



## MAN UP

The MU series is a special truck with multidirectional steering for long loads at high lifting heights.

It is characterized by its compact design and is especially suitable for narrow aisle storage applications. During the handling of loads, the man-up cabin ensures an optimum view at all storage rack levels. With this version, time is saved and loads are safely stored in the rack system, even at great lift heights. The man-up cabin is recommended for lift heights exceeding 7 metres.

Series	Man Up
Load capacity (t)	2.0 to 12.0
Load bed width (mm)	800 to 2100
Lift height (mm)	up to 12500
Frame length (mm)	3170 / 3500
Load bed opening (mm)	1630 / 1960
Tyre equipment	PU
Battery voltage (V)	80 V
Cabin	MU





---

# Optimal and comfortably equipped

---

All HUBTEX trucks are designed to exactly match the users application and requirements. HUBTEX offers a wide range of options to ensure the equipment operates as safely and efficiently as possible.

## ➤ TYRE EQUIPMENT

For different requirements, HUBTEX offers polyurethane tyres (PU) for even industrial floors and, optionally, soft elastic tyres (EL) for poor ground or floor conditions or for outdoor use to preserve the vehicle components and the driver's health.



Polyurethane (PU)

Elastic (EL)

Elastic with profile (EL)

## ➤ LIGHTING



“See and be seen” is the motto of this feature. HUBTEX offers several lighting options within the chassis frame for optimal safety on your company premises.

## ➤ ELECTRIC DRIVE WITH CAN-BUS TECHNOLOGY

All HUBTEX electric multidirectional sideloaders are based on the latest technologies. They are equipped with powerful three-phase AC drives (travel motors) and three-phase AC pump units which offer considerable advantages:

- *Maintenance-free enclosed motor construction with improved protection against moisture and dirt, especially suitable for outdoor application*
- *Strong three-phase AC motors for optimal running characteristics on ramps and gradients. An “Anti-Rollback” feature ensures safety and gives the driver confidence when the vehicle is stopped on gradients*
- *High speed and very good acceleration values*
- *Precise driving of speed control for accurate positioning*



### ➤ MULTIDIRECTIONAL STEERING SYSTEM

In **lengthwise drive**, your HUBTEX sideloader can quickly transport long material through narrow doors and aisles. In **crosswise drive**, the HUBTEX sideloader can be used as conventional frontloader. **Circle drive** enables a fast turning of the truck. **Diagonal drive** ensures safe handling to load and unload lorries.

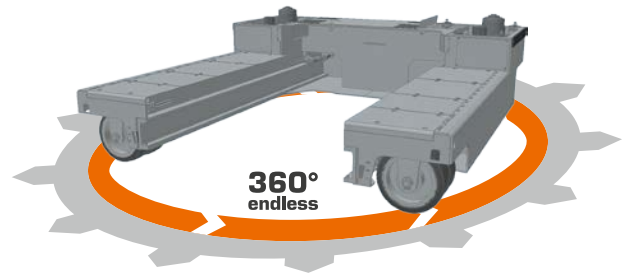

### ➤ MULTIDIRECTIONAL STEERING SYSTEM HX

The trucks mobility is a great advantage and can save up to 50% of the storage space.

By using the optionally available steering system HX, HUBTEX trucks can change without stopping from longitudinal to transverse drive. This reduces the time needed to switch wheels, provides excellent manoeuvrability and has the added benefit of significantly reducing the wear on the wheels. Low wear and high handling performance is paramount.

Another advantage is the significantly reduced wear of the wheels. The change in direction occurs while driving, so the wheels no longer turn on the spot.

Typical applications for the new steering system are operations with lots of changes of direction in warehouses with free movement, loading and unloading trucks or in block storage applications.

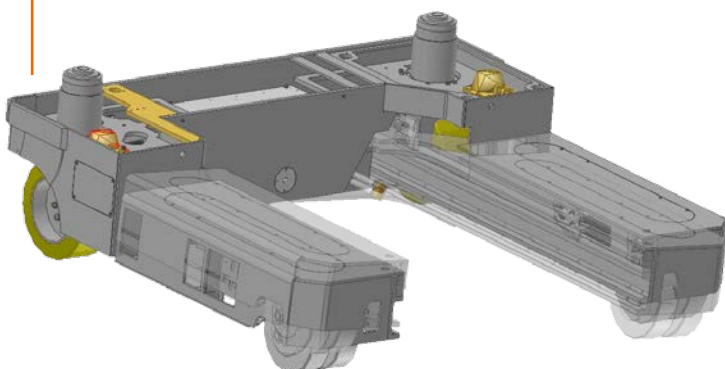

### ➤ ARTICULATED FRAME

The two-piece articulated chassis frame which has been tried and tested over decades ensures permanent floor contact of all wheels to immediately compensate for uneven floor or ground. This exclusive design makes the truck extremely stable and allows high residual capacities at very high lift heights. Cracks in the chassis frame are closed off.





Telescopic fork carriage

## ➤ LIFT MASTS AND FORK CARRIAGES

Stable and strong lift masts with internally reeved hydraulics (No hose reels) are manufactured “in-house” and have a high reserve of load capacity. HUBTEX manufactures different lift masts and fork carriages for the safe and efficient handling of all loads. A hydraulic fork adjusting device and a side shifter are available as option.

### Telescopic fork carriage

For extremely unstable long loads or different load lengths, HUBTEX manufactures telescopic fork carriages which are optionally offered with 2 or 4 forks. Version and adjustable range are adapted to the specific load requirements of the customer.

Typ I  
fork carriage  
Simplex  
mast



Typ III  
fork carriage  
Triplex  
mast



The fork carriages can be combined with all lift masts.

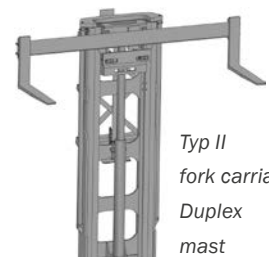

Typ II  
fork carriage  
Duplex  
mast

### Attached fork carriage with two additional forks

For trucks with a short type I carriage a quickly detachable long carriage is available allowing the truck to temporarily lift very long loads. Four forks can be utilized at the same time.



## ➤ FORKS

HUBTEX offers forks for every application. As an essential vehicle component, they have to meet particularly high requirements. Due to the use of high-quality products, least possible wear and high load capacities are ensured.

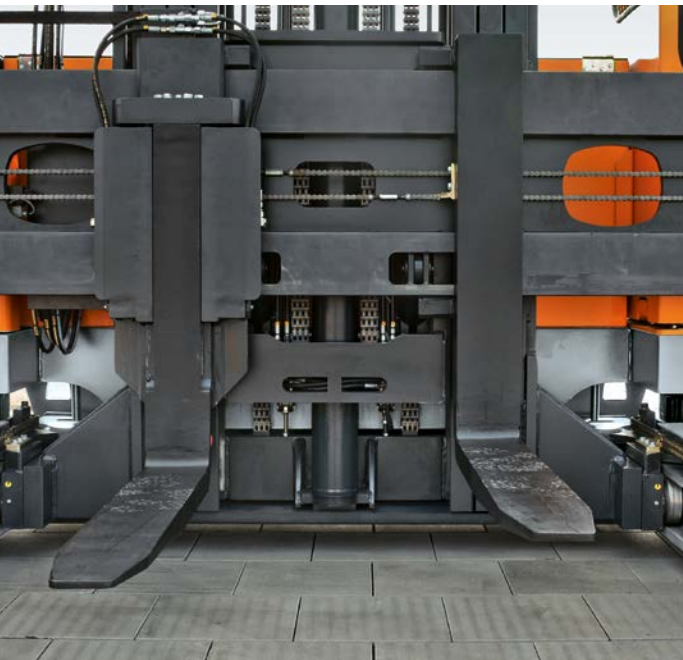

### **Height-adjustable forks (level compensation)**

To compensate for uneven floor or ground, lifting forks are available for all load capacities, also in combination with telescopic forks.

### **Knife type forks (Full taper)**

Knife type forks are available at extra cost for picking up loads in extremely narrow spaces (without illustration).

### **Telescopic forks**

For the loading and unloading of lorries from one side or for the double-deep storage of goods in rack systems, the HUBTEX sideloaders can be equipped with telescopic forks (manual or hydraulic) which are available in all lengths and load capacities.

*Normal (base) position*



*Extended telescopic forks*





## ➤ STORAGE AIDS

For the safe and efficient handling of goods at great lift heights or in narrowly dimensioned rack aisles, HUBTEX offers additional storage aids.

### Video camera with flat screen



Cameras carry out valuable work in many industrial sectors. They increase the safety, improve the driver's view during the storage operation and optimize the utilization of the sideloader. The product range comprises robust and compact cameras and displays, a large number of special cables and plug connections which ensure smooth and permanent image transmission. They are optionally mounted onto the forks, the fork carriage or the lift mast.

### HUBTEX Load Manager (HLM)

The HLM can be freely programmed as electronic lift height preselection with 99 positions. The lift mast stops automatically upon reaching the preselected rack compartment level. In this process, the system distinguishes whether goods are placed in storage or are removed from the storage rack. In this way, time is saved and damage to the goods is ruled out, since the sideloader does not need to plunge into the rack compartment in an uncontrolled manner.

### Further accessories

- intermediate lift limitation
- mast reach limitation
- Secutex coating
- lift height indicator
- load moment monitoring
- audible warning signal
- distance warning sensors
- radio/CD-Player
- and many more

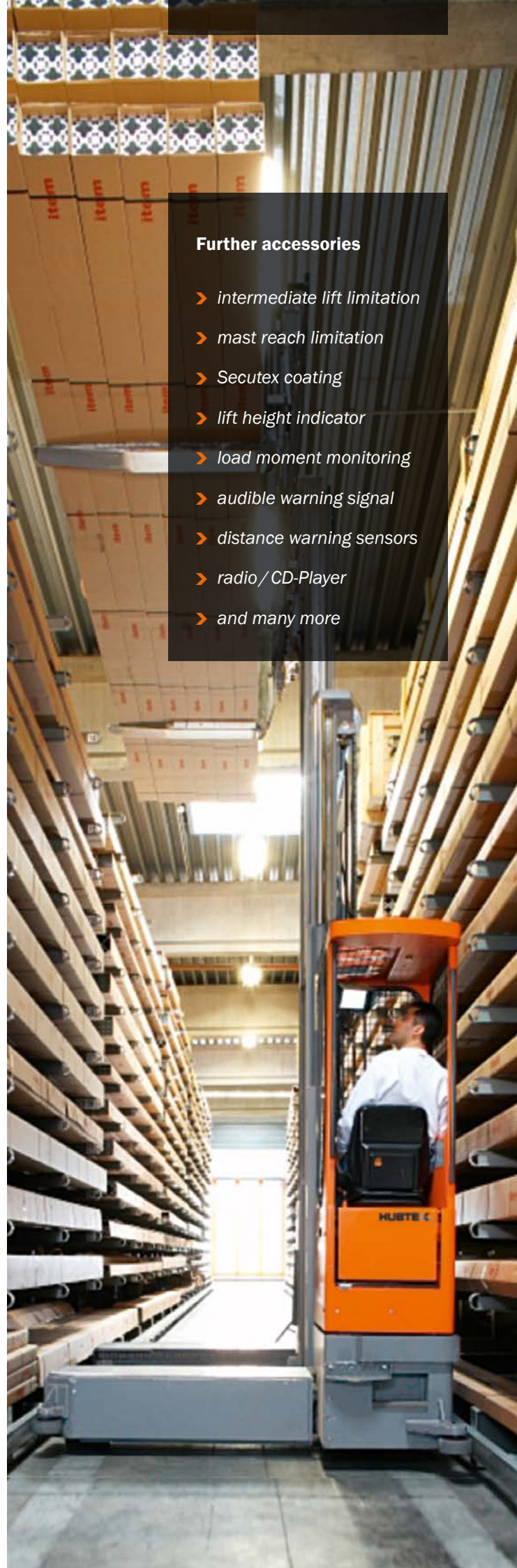



## Cabin accessories

- working headlamps, can be manually adjusted from the cabin
- LED working headlamps on the cabin roof, can be manually adjusted
- warning beacon
- cabin interior lighting
- radio/CD including two loudspeakers
- all-round cabin windscreen
- lockable door with sliding window (Q cabin)
- electric heating
- screen wiper
- heatable driver's seat (Q cabin)





➤ **CABIN VERSIONS FOR THE SMALLEST POSSIBLE AISLE WIDTHS OR FOR THE HIGHEST POSSIBLE COMFORT**

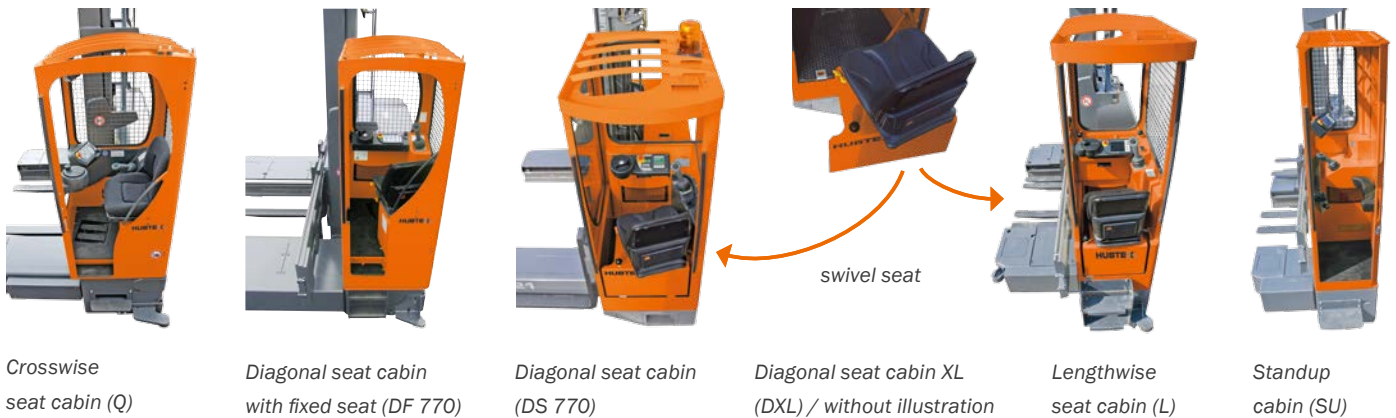

**Ergonomics**

The spacious and ergonomically designed driver workstation offers plenty of elbow room and optimal all-round visibility. The vibration damped cabin as well as the full suspension, multiply adjustable comfort seat provide for smooth working without getting tired and preserve the driver's health.

**Joystick with integrated driving direction switch**

All main driving and hydraulic functions are controlled from a single ergonomically designed joystick developed by HUBTEX. The joystick offers fully proportional lift/lower, mast reach and fork tilt, plus optional fork positioning and teleforks, without moving the hand from this single controller.

**HIT3 HUBTEX- Informations Terminal**



Most modern industrial on-board computer technology on HUBTEX sideloaders allows easy access to driver and service information at a single glance.

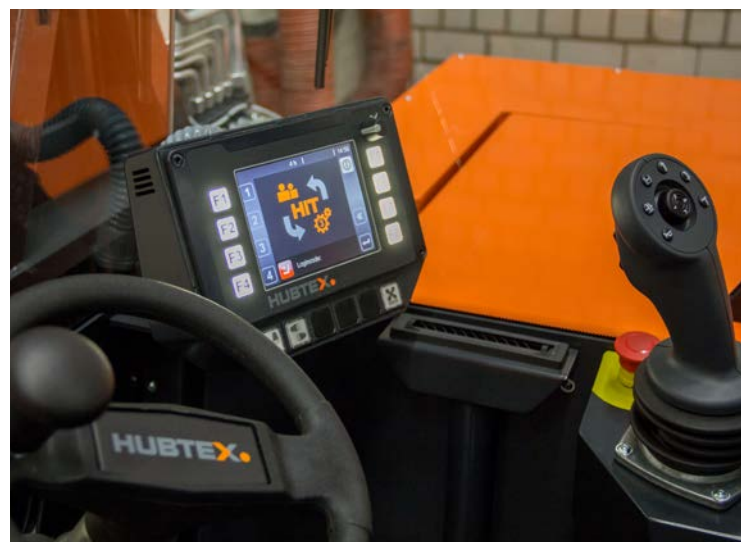



Guide rollers

### Guide rollers

Guide rollers (100 mm safety distance on each side) in single version up to 4.5 t and in twin version from 4.5 t. This mechanical guidance is robust and has been proven in practice.

### Wire guidance

The wire guidance (150 mm safety distance on each side) is a reliable and safe system with the advantage that the guide wire moves your HUBTEX sideloader into the lane before the latter enters the rack system. In this way, damage to the sideloader or the rack system is ruled out. For this purpose, an iron-free space is required in the area of the guide wire, according to DIN 15185 Part 1. If an investment is made in a new vehicle, this system is the most cost-effective guidance system from an aisle length of > 400 linear metres.

## ➤ TRACK GUIDANCE SYSTEMS

HUBTEX offers three different track guidance systems for narrow aisle solutions for the maximum utilization of the available storage space. With a safety distance as low as 100 mm on each side, the aisle width is reduced to a minimum.

### Optical guidance

The optical guidance system (150 mm safety distance on each side) is based on the wire guidance technology and is used when the required iron-free space is not available in the floor for the guide wire.

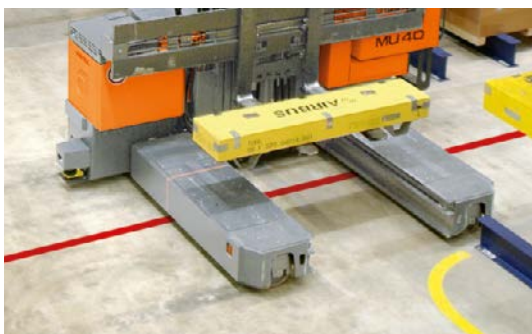

Wire guidance



Optical guidance



## ➤ PERSONAL PROTECTION SYSTEMS IN THE NARROW AISLE WHERE SIDeloadERS MOVE IN GUIDED OPERATION

In the case of aisle widths (AST) with safety distances of less than 500 mm on each side, the system operator is obligated to install approved personal protection systems according to DIN 15185 Part 2 "Protective devices in storage and narrow aisles". HUBTEX offers two different personal protection systems. Both systems comply with the valid guideline.

### **HUBTEX stationary aisle protection system, SGA**

With the stationary aisle protection system, HUBTEX offers an alternative to the mobile PSA. The SGA is an automatically operating safety device and is used for the protection of persons during the operation of industrial trucks in narrow aisles. It is officially approved as risk minimizing measure for the operation of a narrow aisle warehouse. It is regarded as cost-effective alternative for warehouses with up to three rack aisles. If desired, further functions can be performed by the SGA: Monitoring of escape doors/escape routes.



*personal protection system, model PSA*

### **HUBTEX mobile personal protection system, model PSA**

The rack aisle is permanently monitored by means of two laser scanners. If the laser scanners detect persons or obstacles within their protection field in the aisle, your HUBTEX side loader will be automatically brought to a standstill, independently of the driver's/operator's actuation. For the activation/ deactivation, the HUBTEX side loader is equipped with two aisle recognition systems.





---

## Step-by-step automation

---

HUBTEX' electric multidirectional sideloaders are suitable for a diverse range of applications, ensuring the safe transport of loads in warehouses. HUBTEX already offers a large number of systems that build on each other.

The path leads from assisted driving, for example with intelligent route guidance, to lane-guided driving and autonomous driving. In the future, even complex transport tasks

can be carried out automatically and multidirectional sideloaders fully integrated into automated production processes.

This particularly benefits customers with large inventory turnovers, who profit from reduced process costs coupled with a reduction in operating costs as well as optimised material flows and an increase in efficiency



---

## Remote maintenance system

---

A new remote maintenance system is available for HUBTEX trucks. A machine-to-machine (M2M) gateway is fitted to the forklifts and used to transfer data, e.g., the charging condition of the battery, to the Cloud of the company's system partner Telekom.

HUBTEX technicians can directly access the data of the truck and provide fast assistance in the event of vehicle malfunctions.

Customers benefit from predictive maintenance, maximum machine availability and minimised production losses.



### ➤ REMOTE MAINTENANCE SYSTEM AT A GLANCE:

- *automatic exchange of information between vehicle and service*
- *data transfer of operating hours, the battery charging condition as well as error codes*
- *available with functions for parameter modifications and software updates*
- *maximum machine availability, minimised production losses and service intervention*

---

## Rental or financing

---

### ➤ FINANCING SOLUTIONS

HUBTEX holds an equipment fleet of 50 vehicles ready for short or long-term rental. This is one of the largest sideloader fleets offered for rental on the market. Thus, we can offer you a suitable solution for your application, as well.

Apart from that, we are pleased to offer you the appropriate financing model for your new HUBTEX sideloader. Our range of options from hire purchase to full rental which includes maintenance and repair is available to suit our customers needs.

## ➤ MORE SERVICE

Exactly calculable maintenance costs due to factory guidelines with regard to service times.

Fastest possible solution of problems by comprehensive factory support.

## ➤ MORE VALUE

Due to the exclusive use of original spare parts, your truck remains an original HUBTEX.

Customized maintenance concepts provide you with a clearly calculable cost structure.

## ➤ MORE SAFETY

You can be sure that all safety-related equipment of your truck is checked by competent, specialized technicians according to the latest guidelines at least once per year.



---

# Your HUBTEX moves on and on ...

---

Who should understand your HUBTEX better than we do? Apart from excellent service, HUBTEX offers you long-term investment security which is indeed "the manufacturer's know-how".







**HUBTEX.**

*WIR BEWEGEN!*

**SERV**

HT 102

## HUBTEX VEHICLES

---

ELECTRIC-MULTIDIRECTIONAL-SIDELOADERS › DIESEL-/GAS-FOUR-WAY-SIDELOADERS › MULTIDIRECTIONAL COUNTERBALANCE FORKLIFT › ORDER PICKING SYSTEMS › GLASSTRANSPORT SYSTEMS › HEAVY DUTY TRANSPORT VEHICLES › REACH TRUCKS › SPECIAL TRUCKS › SECOND-HAND-AND RENTAL EQUIPMENT

---

# HUBTEX.

WE CREATE THE UNIQUE

---

HUBTEX MASCHINENBAU GMBH & CO. KG · Industriepark West · Werner-von-Siemens-Str. 8 · 36041 Fulda, Germany  
Tel.: +49 661 8382-0 · Fax: +49 661 8382-120 · info@hubtex.com · www.hubtex.com